

Strain relief collar  
Protective Cap  
Plug  
Wire cap

**NOTE:**  
Steps 1-5 show cable preparation method for TX6A and TX6A-SD Cable with MaTriX Technology

**1** **NOTE:** Use setting 9 of CFAST tool. Turn 2 times to cut through the outer jacket and MaTriX tape only.

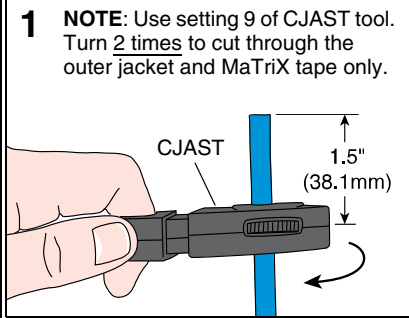

CFAST  
1.5" (38.1mm)

**2**

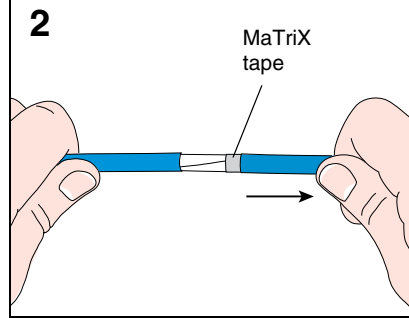

MaTriX tape

**3**

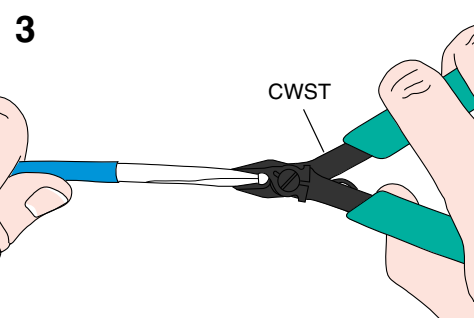

CWST

**4**

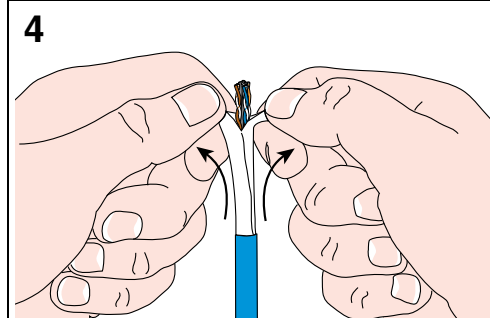

**5**

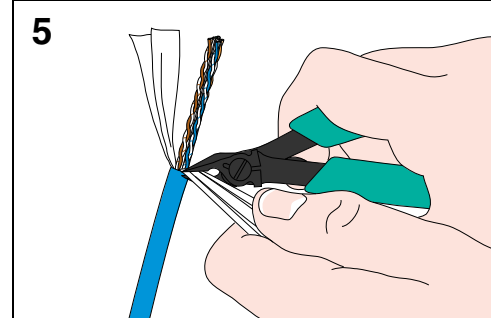

**6**

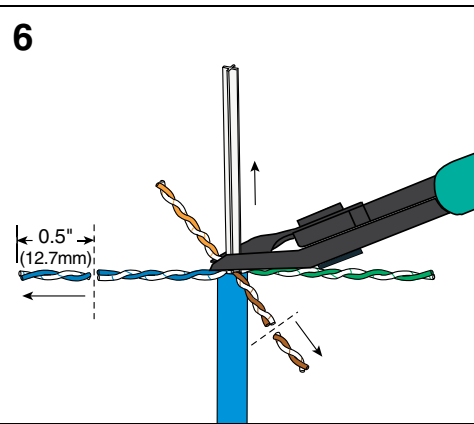

0.5" (12.7mm)

**7**

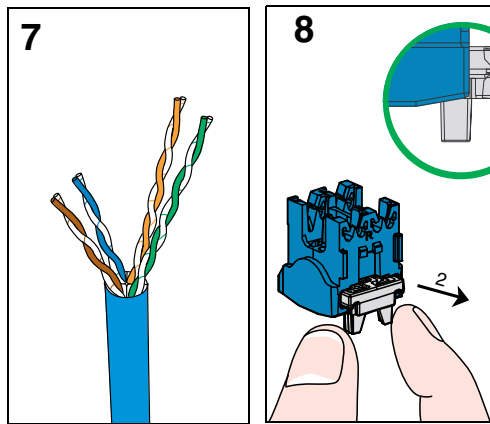

**8**

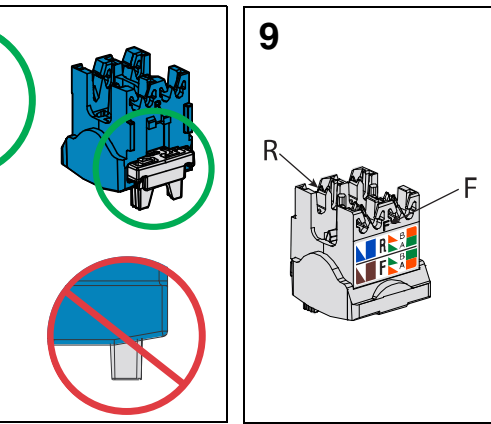

**9**

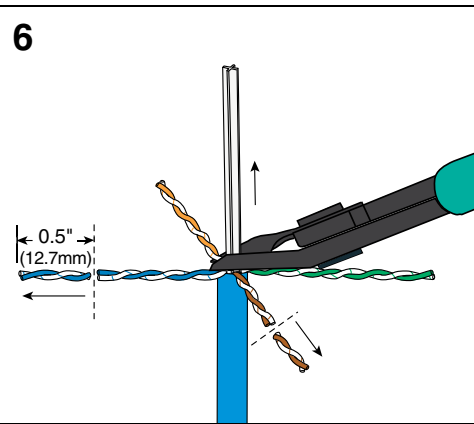

R  
F

**10**

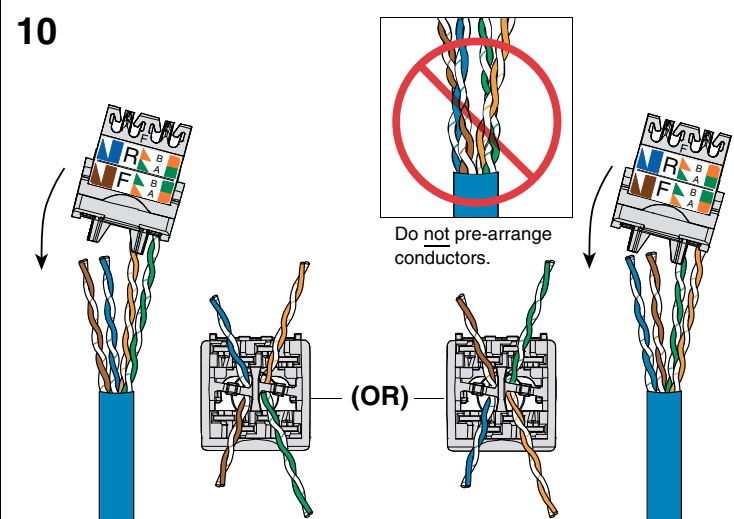

Do not pre-arrange conductors.  
(OR)

**11**

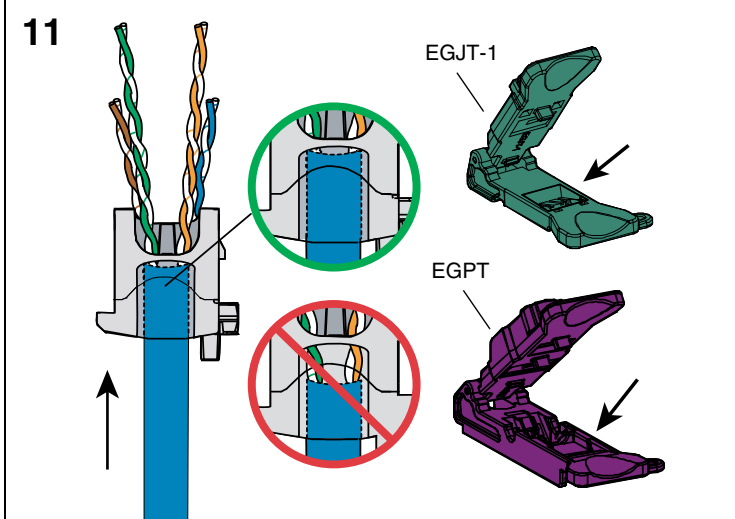

EGJT-1  
EGPT

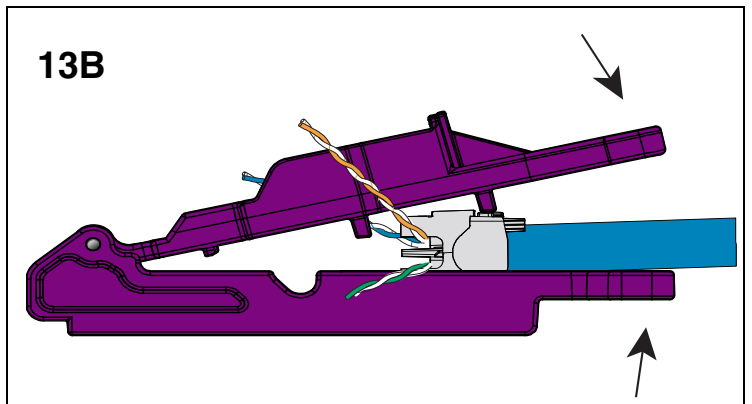
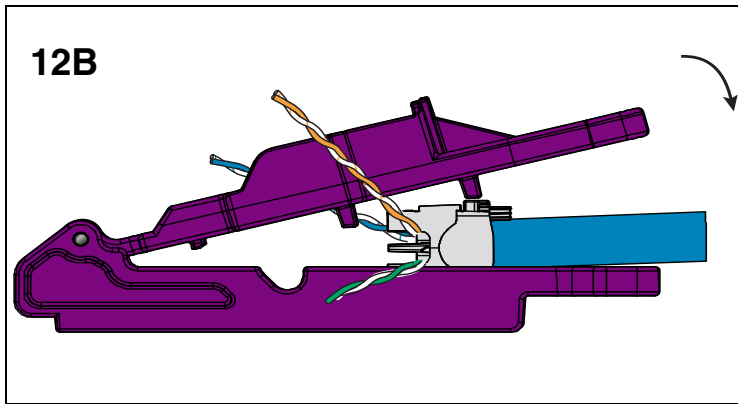
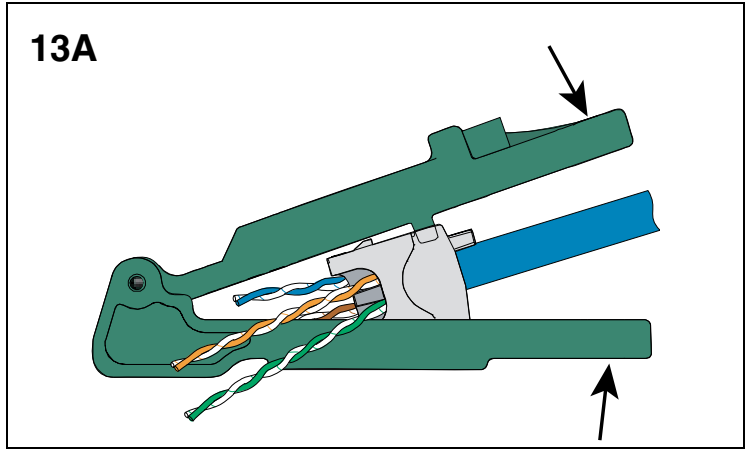
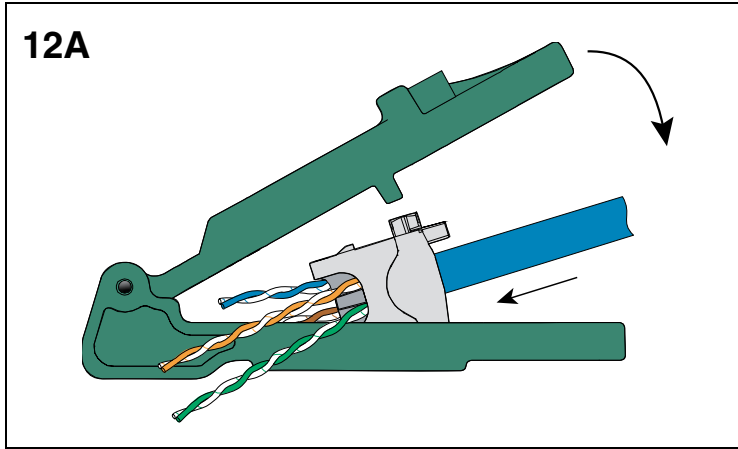

**12 T568B Wiring**

**Color Key:**  
R: Blue (B), Orange (A)  
F: Brown (B), Green (A)

**Step 1:** Insert the four twisted pairs into the jack.

**Step 2:** Straighten the wires and trim them to the correct length.

**Incorrect Wiring (Red circles with slashes):**  
- Crossing wires between R and F sides.  
- Crossing wires within the R or F side.

**12 T568A Wiring**

**Color Key:**  
R: Blue (B), Green (A)  
F: Brown (B), Orange (A)

**Step 1:** Insert the four twisted pairs into the jack.

**Step 2:** Straighten the wires and trim them to the correct length.

**Incorrect Wiring (Red circles with slashes):**  
- Crossing wires between R and F sides.  
- Crossing wires within the R or F side.

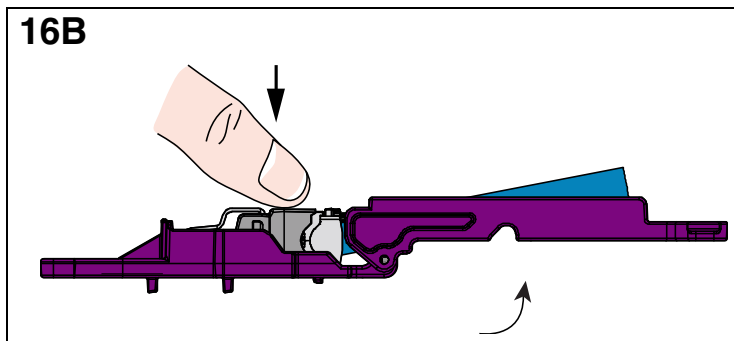
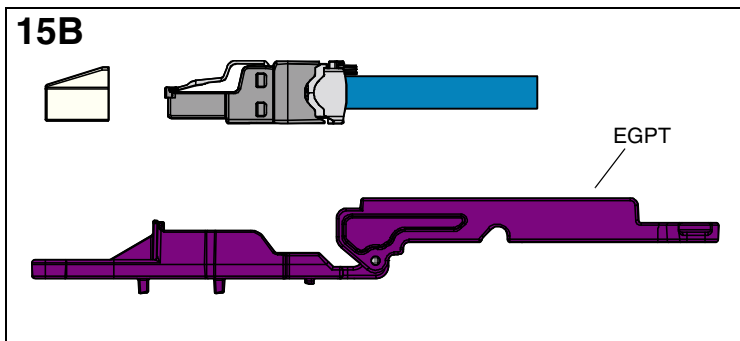
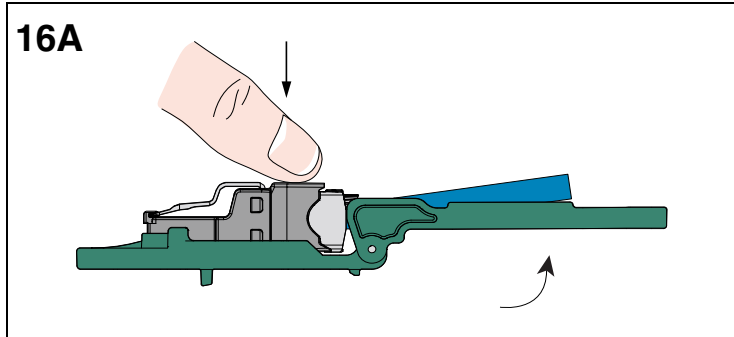
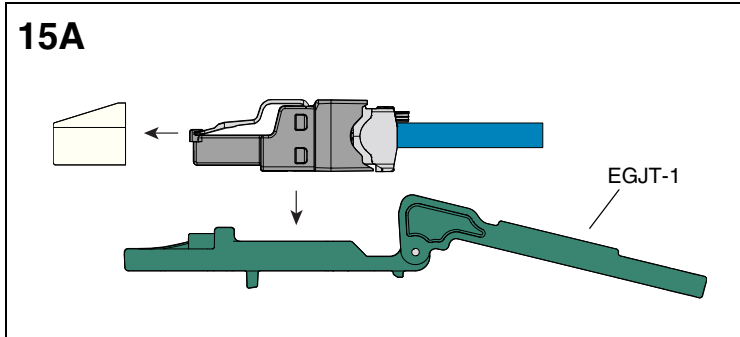
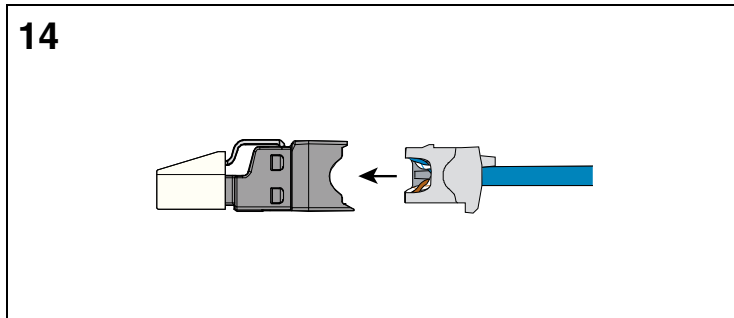
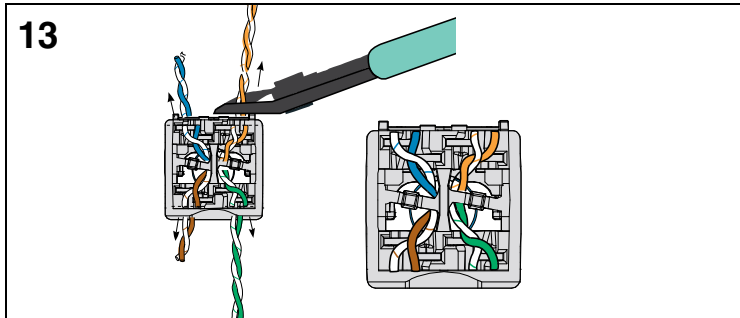

**REMOVAL STEPS**

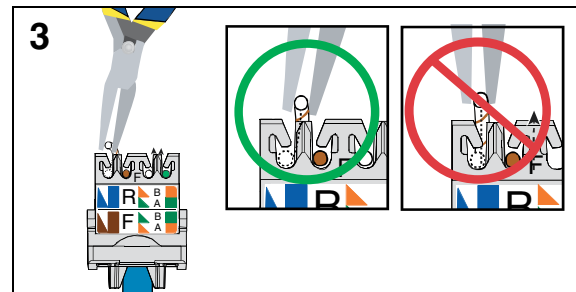
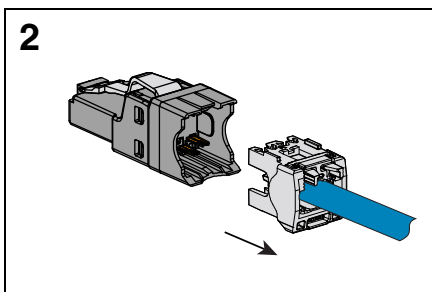
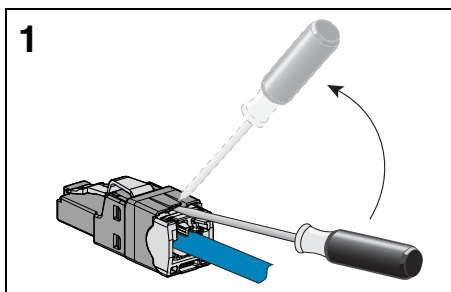

**Notes:**

1. For specified performance, follow TIA/EIA 568-C installation guidelines.
2. Plug module can terminate 22-26 AWG solid or stranded IWC data cable with 0.062" (1.57mm) maximum insulated conductor outside diameter.
3. Plug module may be re-terminated a minimum of 20 times.
4. For technical and performance information, consult Panduit technical support.

**As with all Wiring Accessories, the following statements apply:**

1. Never install communications wiring during a lightning storm.
2. Never install communications wiring in wet locations unless the plug is specifically designed for use in wet locations.
3. Never touch uninsulated communications wiring or terminals unless the communication line has been disconnected at the network interface.
4. Use caution when installing or modifying communication wiring.

For Instructions in Local Languages  
and Technical Support:  
[www.panduit.com/resources/install\\_maintain.asp](http://www.panduit.com/resources/install_maintain.asp)

**PANDUIT**  
[www.panduit.com](http://www.panduit.com)

E-mail:  
[techsupport@panduit.com](mailto:techsupport@panduit.com)  
Phone:  
866-405-6654